

Features

- Frameless design emphasizes glass and creates a sleek, minimalist look.
- Vertical handle with inside knob on moving panel.
- Gently-curved towel bar provides integrated storage on fixed panel.
- Tempered glass ensures maximum safety and durability.
- CleanCoat®+ glass coating creates a hydrophobic barrier that repels water, soap scum, and residue, saving time and protecting shower doors 10 times longer than original CleanCoat. (Based on 2021 internal wear/abrasion testing using a microfiber cloth.)
- Smooth, easy-to-clean wall jambs.
- Full-length moving panel seal provides excellent water containment.
- Upgrade to heavy 5/16" (8 mm) thick glass and tall height shower door by selecting K-707615-8G79.
- Coordinates with other items in the Elate collection.

Material

- Frameless, 1/4" (6 mm) thick Crystal Clear tempered glass with rectangular grille pattern.
- Anodized aluminum prevents rust and corrosion.

Installation

- Fits opening widths 56-1/4" - 59-5/8" (1429 - 1514 mm).
- 70-1/2" (1791 mm) high, with 67-11/16" (1719 mm) minimum head clearance.
- 3-3/8" (86 mm) width adjustment.
- Out-of-plumb adjustability simplifies installation.
- Door can be installed to open to the left or right to suit your bathroom layout.
- For residential use only.
- Not for use in hospitality.

Recommended Products/Accessories

K-23723 Faucet cleaner



Codes/Standards

ANSI Z97.1
CPSC 16CFR 1201

KOHLER® One-Year Limited Warranty

See website for detailed warranty information.

Available Colors/Finishes

Color tiles intended for reference only.

Color	Code	Description
■	BL	Matte Black

Available Glass Options

Code	Description
G79	Crystal Clear with Rectangular Grille Pattern

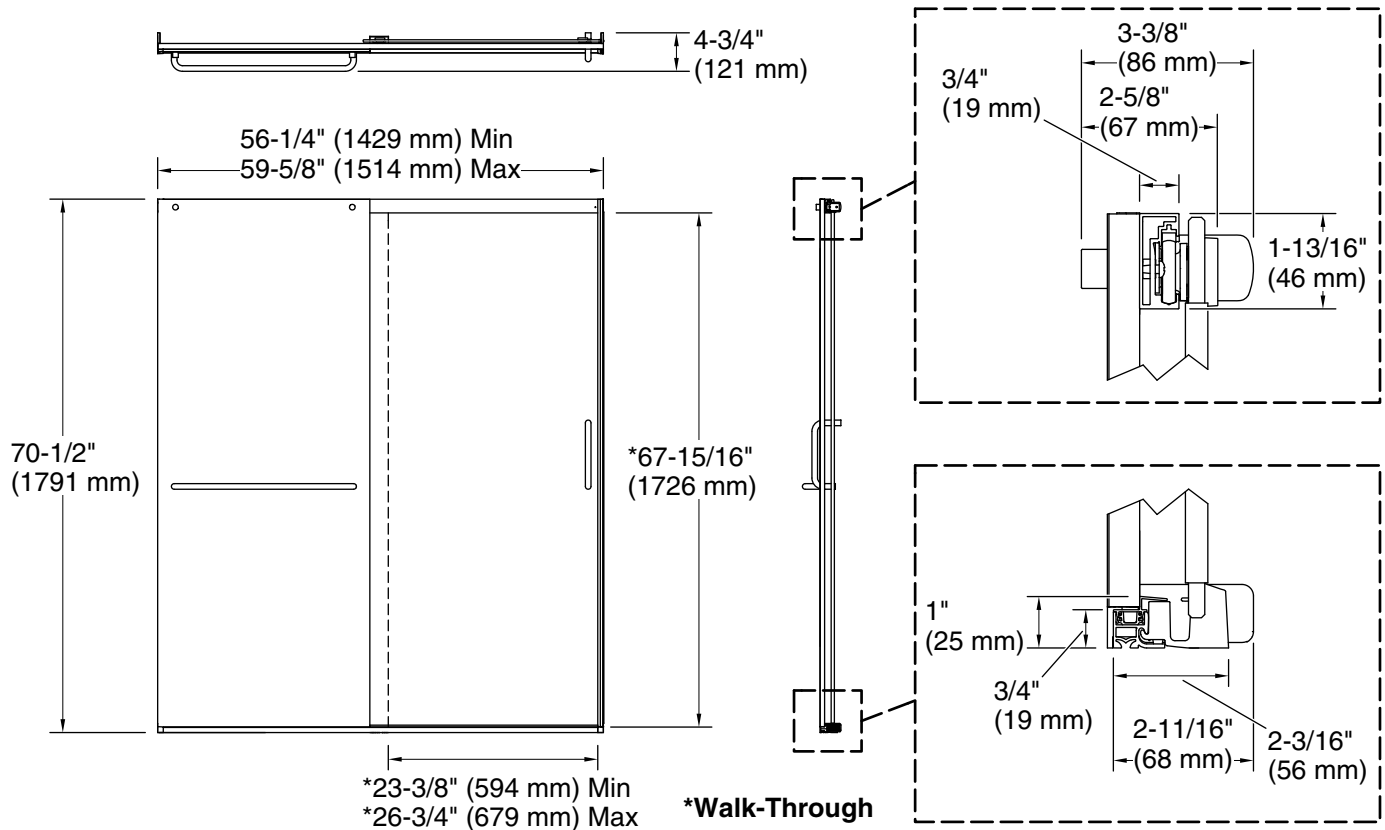

Technical Information

All product dimensions are nominal.

Installation type:	For shower base installation
Opening Width - Min:	56-1/4" (1429 mm)
Opening Width - Max:	59-5/8" (1514 mm)
Walk-through - Min:	23-3/8" (594 mm)
Walk-through - Max:	26-3/4" (679 mm)
Base-To-Wall Radius - Max:	1/2" (13 mm)
Glass thickness:	1/4" (6 mm)
Glass coating:	CleanCoat®

Notes

Install this product according to the installation instructions.

The vertical opening should be a minimum of 73-13/16" (1875 mm) to allow for installation clearance.